

Frost Fighter[®] Defroster Connector Replacement

Professional grade rear window defroster repair

Connector Part No. 2320
Master Kit Part No. 2875

www.frostfighter.com

The Frost Fighter Uni-Con Kit replaces lost or broken automotive rear window defroster connectors. When main power tabs separate from the defroster these connectors can be lost or damaged.

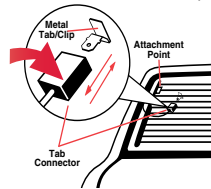

The Uni-Con Connector Kit includes both the connector and cover replacements parts.

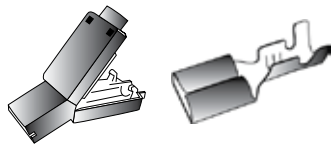

Connector Cover

Connector

If the metal tab is damaged or missing replace with the Frost Fighter Uni-Clip kit.

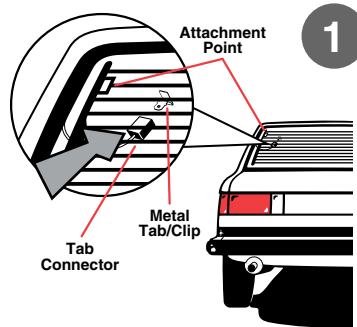

1 Locate tab connector along edge of rear window

Turn defroster off. Locate the tab connector along the side of the rear window. **The Uni-Con Connector Kit replaces lost or damaged rear window defroster connectors.** If the metal tab/clip is damaged replace it with the Frost Fighter Uni-Clip kit.

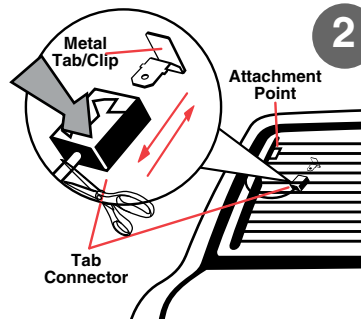

2 Remove the broken tab connector

Cut the wire leading to the damaged connector as close to the connector as possible. Wire cutters are preferred.

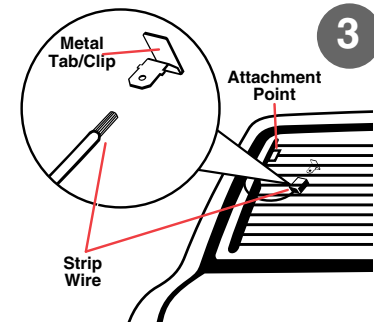

3 Strip back wire insulation

Strip back approximately 1/4 inch of wire insulation from the defroster main power wire. This is best done with a wire stripper being careful not to cut any of the wire strands.

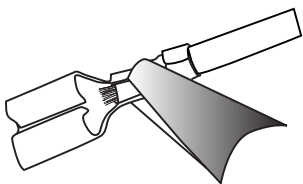

4 Insert wire in connector and crimp

Place the stripped wire into the connector and bend the tabs to secure. Using pliers to crimp the connector to the main wire on the defroster. The short outer tabs capture the wire insulation for strain relief and the larger (inner) tabs go directly on the wire.

Be careful not to apply too much force and damage the connector

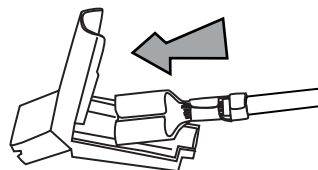

5 Insert connector in housing and close

Insert the connector into the black housing making sure to seat the metal end all the way into the housing and snap close.

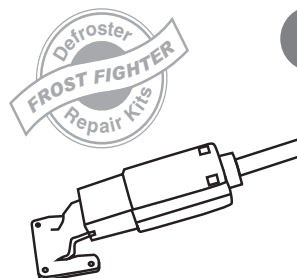

6 Re-attach connector to tab

Re-attach the main power wire to the defroster by pressing the Uni-Connector GENTLY onto the defroster tab. **WORK THE CONNECTOR ON SLOWLY AND DO NOT FORCE IT!** Turn on and test the defroster. Once the connector has been replaced the defroster should work properly. If not, be sure check the fuses. If the fuse checks out then visually inspect the metal tab/clip to see if it is making a good connection with the defroster grid.

WARNING:

Warranty and Disclaimer:

Since the Seller cannot control the manner or use of its products after their sale, Seller will not be responsible for any consequential or indirect damages. There are no express warranties which extend beyond the description on the face hereof. Seller disclaims any implied warranties of merchantability or fitness for any particular purpose. The Seller will, at its option, either replace the products sold or refund the purchase. No warranties will apply if the products are in any way altered or modified after delivery by Seller.

Frost Fighter™ is a trademark of
Planned Products LLC
© 1998-2013 Planned Products
MADE AND PRINTED IN USA

Troubleshooting Tips
www.frostfighter.com